

Data Sheet



Article number: 03705022

Description: Fluro rod end BRM 22 L
threaded left with ball bearing

Measures

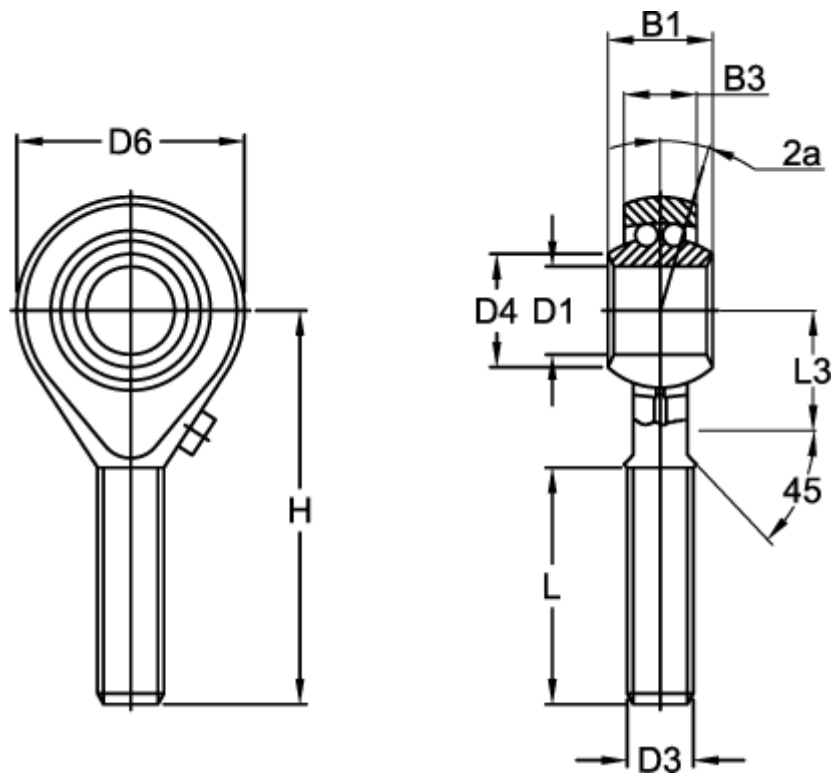

Angel 2a	= 8.0	H	= 84
B1	= 28	L	= 51
B3	= 20.00	L3	= 26
D1	= 22	Max rpm	= 725
D3	= M22x1,5	Static load (N)	= 3980
D4	= 26.0	Weight (kg)	= 0.450
D6	= 54		
Dynamic load C (N)	= 9300.0		